

合格证  
QC PASS

# Godox

## fotichaestli.ch

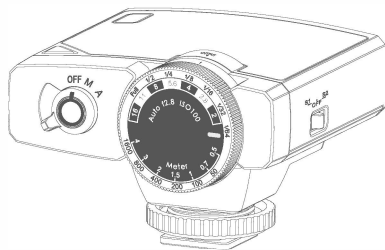

Wechat  
Official Account  
神牛微信公众号

深圳市神牛摄影器材有限公司

地址: 深圳市宝安区福海街道塘尾社区耀川工业区厂房2栋 电话: 0755-29609320(8062)

传真: 0755-25723423 邮箱: godox@godox.com

**GODOX Photo Equipment Co., Ltd.**

Add.: Building 2, Yaochuan Industrial Zone, Tangwei Community, Fuhai Street, Bao'an District, Shenzhen 518103, China Tel: +86-755-29609320(8062)

Fax: +86-755-25723423 E-mail: godox@godox.com

[www.godox.com](http://www.godox.com)

Made in China | 705-LUXJU0-01



# Lux Junior

复古闪光灯

Retro Camera Flash

说明手册

Instruction Manual

## Foreword

The Lux Junior is designed with a compact structure, retro appearance, and practical functions. It can provide a guide number of GN12 at ISO100, auto flash and manual flash mode, support two AAA batteries power supply, be compatible with various kinds of cameras, such as Canon, Nikon, Fujifilm, Olympus, Sony, etc.

### ⚠ Warning

- ⚠ Always keep this product dry. Do not use in rain or in damp conditions.
- ⚠ Do not disassemble. Should repairs become necessary, this product must be sent to an authorized maintenance center.
- ⚠ Keep out of reach of children.
- ⚠ Stop using this product if it breaks open due to extrusion, falling or strong hit. Otherwise, electric shock may occur if you touch the electronic parts inside it.
- ⚠ Do not leave or store the flash unit if the ambient temperature reads over 50 C.
- ⚠ Do not fire the flash directly into the eyes (especially those of babies) within short distances. Otherwise, visual impairment may occur.
- ⚠ Do not use the flash unit in the presence of flammable gases, chemicals and other similar materials. In certain circumstance, these materials may be sensitive to the strong light emitting from this flash unit and fire or electromagnetic interference may result.
- ⚠ Turn off the devices immediately in the event of malfunction
- ⚠ Do not use any batteries, power sources or accessories not specified in the instruction manual.
- ⚠ Keep batteries and other accessories out of the reach of children and infants. In the instance that a child or infant swallows a battery or accessory, immediate emergency medical attention is required.
- ⚠ Do not use any deformed or modified batteries.
- ⚠ Do not disassemble or modify this product or battery.
- ⚠ Do not heat or solder the battery.
- ⚠ Keep the battery away from fire or water.
- ⚠ Do not let the battery subject to strong external impact.
- ⚠ Do not connect metal objects to the positive and negative ends of the battery.
- ⚠ Do not incorrectly insert the positive and negative ends of batteries, or mix old and new batteries or batteries of different types together.
- ⚠ If the battery leaks, becomes discolored, deformed, emits smoke, or emits an abnormal odor, remove it immediately. Be careful during removal to avoid burns. Continued use could result in fire, electric shock, or burns.

## Product Structure

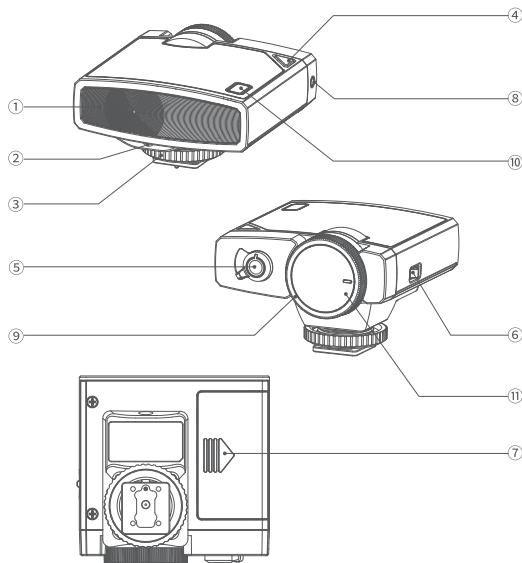

- |  |                            |
|--|----------------------------|
| 1. Light-emitting area                                 | 6. OFF/S1/S2 button        |
| 2. Auto light receptor                                 | 7. Battery compartment     |
| 3. Hotshoe   | 8. SYNC hole               |
| 4. Test button/Recycle indicator                       | 9. Power adjust dial       |
| 5. OFF/M/A dial<br>(power off/manual flash/auto flash) | 10. Optical control sensor |
|  | 11. Meter panel            |

## Power Adjusting Instruction

Power adjust dial is rotatable in 7 levels, while meter panel is steplessly rotatable with data on it, together precisely setting and adjusting power.

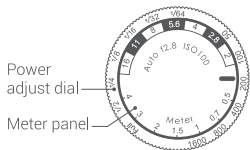

## Recycle Indicator Instruction

1. When the recycle indicator is constant on red, it means recycling.
2. When the recycle indicator is constant on green, it means recycle complete.
3. When the recycle indicator flashes red stably, it means low battery state, please replace the battery in time.
4. When the recycle indicator flashes rapidly, it means high temperature state.
5. When the recycle indicator is off, it means battery is dead.

## What's In Side



Retro Camera Flash \*1



Triggering Cable\*1



Instruction Manual\*1



Storage Bag \*1

## Power adjust dial/Meter panel Settings Instruction

ISO Values	50	100	200	400	800	1600	
Flash Power Levels	Full	1/2	1/4	1/8	1/16	1/32	1/64
Aperture Values	2	2.8	4	5.6	8	11	16
Best Shooting Distance	0,5	0,7	1	1,5	2	3	4

## Battery Installation Instruction

Open the battery compartment, the plumped end marked with + is positive pole, the sunk end marked with - is negative pole, put two batteries into the battery compartment correctly, then close the cover and push it upwards.

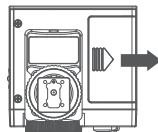

## Operation Instruction Power On

Turn the OFF/M/A dial to M manual flash mode or A auto flash mode, the device can be powered on. Turn it to OFF mode, the device is powered off.

**Note:** Install the flash to the camera then turn on the camera and flash.

## M Manual Flash Mode

1. Turn the OFF/M/A dial to M manual flash mode.

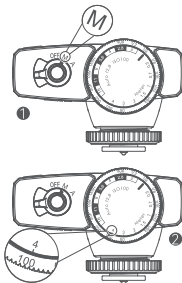

2. According to the ISO value (assuming the ISO value is 100) of the camera, find the ISO value on the power adjust dial. Then turn the meter panel to make the distance value aimed at the ISO value according to the current shooting distance (assuming the distance is 4m).

3. The flash power is the value on the dial aimed at the aperture value (assuming it is f2.8). In the above assumptive situation, the flash power should be Full(1) power. Turn the power adjust dial to make the power value (1) aimed at the OUTPUT arrow, then the flash is ready for use.

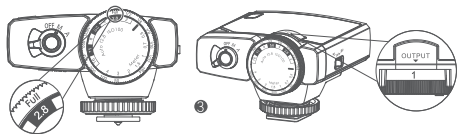

## Practical Form of M Manual Flash Mode

Aperture GN Distance	2	2.8	4	5.6	8	11	16
48	24	16.8	12	8.4	6	4.2	3
33.6	16.8	12	8.4	6	4.2	3	2.1
24	12	8.4	6	4.2	3	2.1	1.5
16.8	8.4	6	4.2	3	2.1	1.5	1
12	6	4.2	3	2.1	1.5	1	0.7
8.4	4.2	3	2.1	1.5	1	0.7	0.5
6	3	2.1	1.5	1	0.7	0.5	0.4
4.2	2.1	1.5	1	0.7	0.5	0.4	0.3
3	1.5	1	0.7	0.5	0.4	0.3	0.2
2.1	1	0.7	0.5	0.4	0.3	0.2	0.1
1.5	0.7	0.5	0.4	0.3	0.2	0.1	
1	0.5	0.4	0.3	0.2	0.1		
0.8	0.4	0.3	0.2	0.1			

Flash power	ISO GN	50	100	200	400	800	1600
1		8.4	12	16.8	24	33.6	48
1/2		6	8.4	12	16.8	24	33.6
1/4		4.2	6	8.4	12	16.8	24
1/8		3	4.2	6	8.4	12	16.8
1/16		2.1	3	4.2	6	8.4	12
1/32		1.5	2.1	3	4.2	6	8.4
1/64		1	1.5	2.1	3	4.2	6

## A Auto Flash Mode

Turn the OFF/M/A dial to A auto flash mode.

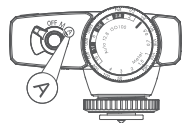

The default ISO and aperture are 100 and f2.8 respectively in A auto flash mode.

## Practical Form of A Auto Flash Mode

ISO	50	100	200	400	800	1600
Aperture	2	2.8	4	5.6	8	11
Distance	Max, 4 meters					

**Note:** Using improper extra long lens may affect the output in A auto flash mode.

## Optical Control Mode

### S1 optical control

The S1 optical control function is available in M manual flash mode. Push the OFF/S1/S2 button to S1, the flash can function as an optical S1 secondary flash. With this function, the flash will fire synchronously when the main flash fires, the same effect as that by using of radio triggers. This helps create multiple lighting effects.

### S2 optical control

The S2 optical control function is available in M manual flash mode. Push the OFF/S1/S2 button to S2, the flash can also function as an optical S2 secondary flash to be suitable for TTL flash. This is useful when cameras have pre-flash function. With this function, the flash will ignore a single "pre-flash" from the main flash and will only fire in response to the second, actual flash from the main unit.

**Note:** S1/S2 optical control is only available in M manual flash mode.

## Technical Data

Model	Lux Junior
GN(1/1 level)	GN12(ISO100, in meters)
Flash power	7 levels: 1/1-1/64
CCT	6000K±200K
Focal length	28mm(fixed value)
Compatible cameras	Fujifilm, Canon, Nikon, Olympus, Sony
Panel display	Power: full,1/2,1/4,1/8,1/16,1/32,1/64 Aperture: F2-16 Distance: 0.5m,0.7m,1m,1.5m,2m,3m, 4m Auto f2.8 ISO100 (default value in A auto flash mode)
Optical flash	S1 optical control/S2 optical control
Working environment temperature	-10 C ~50 C
Battery	Ni-MH battery/ AAA alkaline battery
Dimension	73,8*50,2*71,8mm
Net weight	130g

\* Product design and specifications are subject to change without notice.

## Declaration of Conformity:

GODOX Photo Equipment Co,Ltd. hereby declares that the This equipment are in compliance with the essential requirements and other relevant provisions of EU Directive 2014/30/EU. They are allowed to be used in all EU member states. For more information of DoC, Please click this web link: [https://www.godox.com/DOC/Godox\\_Lux\\_Junior\\_DOC.pdf](https://www.godox.com/DOC/Godox_Lux_Junior_DOC.pdf).

## FCC Statement

This device complies with part 15 of the FCC Rules. Operation is subject to the following two conditions:

- (1) This device may not cause harmful interference, and
- (2) this device must accept any interference received, including interference that may cause undesired operation.

Any Changes or modifications not expressly approved by the party responsible for compliance could void the user's authority to operate the equipment.

Note: This equipment has been tested and found to comply with the limits for a Class B digital device, pursuant to part 15 of the FCC Rules. These limits are designed to provide reasonable protection against harmful interference in a residential installation. This equipment generates uses and can radiate radio frequency energy and, if not installed and used in accordance with the instructions, may cause harmful interference to radio communications. However, there is no guarantee that interference will not occur in a particular installation. If this equipment does cause harmful interference to radio or television reception, which can be determined by turning the equipment off and on, the user is encouraged to try to correct the interference by one or more of the following measures:

- Reorient or relocate the receiving antenna.
- Increase the separation between the equipment and receiver.
- Connect the equipment into an outlet on a circuit different from that to which the receiver is connected.
- Consult the dealer or an experienced radio/TV technician for help.

## Warranty

Dear customers, as this warranty card is an important certificate to apply for our maintenance service, please fill in the following form in coordination with the seller and safe-keep it. Thank you!

Product Information	Model	Product Code Number
Customer Information	Name	Contact Number
	Address	
Seller Information	Name	
	Contact Number	
	Address	
	Date of Sale	
Note:		

Note: This form shall be sealed by the seller.

### Applicable Products

The document applies to the products listed on the Product Maintenance Information (see below for further information). Other products or accessories (e.g. promotional items, giveaways and additional accessories attached, etc.) are not included in this warranty scope.

### Warranty Period

The warranty period of products and accessories is implemented according to the relevant Product Maintenance Information. The warranty period is calculated from the day (purchase date) when the product is bought for the first time, and the purchase date is considered as the date registered on the warranty card when buying the product.

### How to Get the Maintenance Service

If maintenance service is needed, you can directly contact the product distributor or authorized service institutions. You can also contact the Godox after-sale service call and we will offer you service. When applying for maintenance service, you should provide valid warranty card. If you cannot provide valid warranty card, we may offer you maintenance service once confirmed that the product or accessory is involved in the maintenance scope, but that shall not be considered as our obligation.

### Inapplicable Cases

The guarantee and service offered by this document are not applicable in the following cases: ①. The product or accessory has expired its warranty period; ②. Breakage or damage caused by inappropriate usage, maintenance or preservation, such as improper packing, improper usage, improper plugging in/out external equipment, falling off or squeezing by external force, contacting or exposing to the improper temperature, solvent, acid, base, flooding and damp environments, etc; ③. Breakage or damage caused by non-authorized institution or staff in the process of installation, maintenance, alternation, addition and detachment; ④. The original identifying information of product or accessory is modified, alternated, or removed; ⑤. No valid warranty card; ⑥. Breakage or damage caused by using illegally authorized, nonstandard or non-public released software; ⑦. Breakage or damage caused by force majeure or accident; ⑧. Breakage or damage that could not be attributed to the product itself. Once met these situations above, you should seek solutions from the related responsible parties and Godox assumes no responsibility. The damage caused by parts, accessories and software that beyond the warranty period or scope is not included in our maintenance scope. The normal discoloration, abrasion and consumption are not the breakage within the maintenance scope.

## Maintenance and Service Support Information

The warranty period and service types of products are implemented according to the following Product Maintenance Information:

Product Type	Name	Maintenance Period(month)	Warranty Service Type
Parts	Circuit Board	12	Customer sends the product to designated site
	Battery	3	Customer sends the product to designated site
	Electrical parts e.g.battery charger, power cord, sync cable, etc.	12	Customer sends the product to designated site
Other Items	Flash tube, modeling lamp, lamp body, lamp cover, locking device, package, etc.	NO	Without warranty

Godox After-sale Service Call 0755-29609320-8062