

合格证  
QC PASS

Godox

fotichaestli.ch

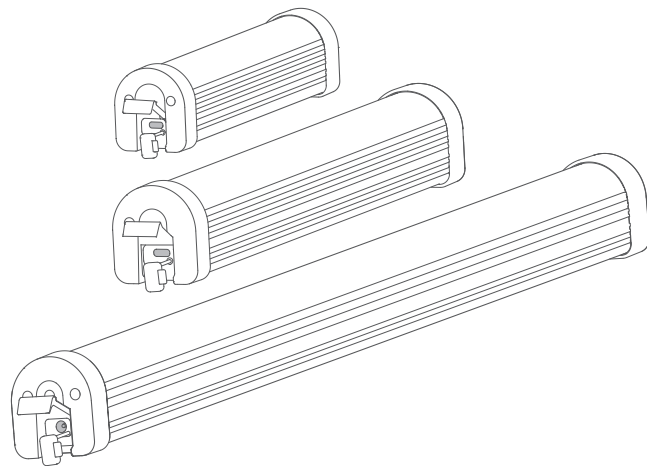

Wechat  
Official Account  
神牛微信公众号

深圳市神牛摄影器材有限公司

地址: 深圳市宝安区福海街道塘尾社区福川工业区厂房2栋 电话: 0755-29609320(8062)

传真: 0755-25723423 邮箱: godox@godox.com

GODOX Photo Equipment Co.,Ltd.

Add.: Building 2, Yaochuan Industrial Zone, Tangwei Community, Fuhai Street, Bao'an District,  
Shenzhen 518103, China Tel: +86-755-29609320(8062) Fax: +86-755-25723423

E-mail: godox@godox.com

godox.com

Made in China | 705-WT25D0-01



WT25D  
WT40D  
WT60D

Dive Light 潜水灯

使用手册

Instruction Manual

20. The safety instructions are formulated according to the strict testing of the factory, and the design and specifications of the equipment are subject to change without prior notice. For latest product information, please check the GODOX website and view latest electronic instruction.
21. Some products have built-in lithium batteries. Please use specified chargers, and use them within a proper range of the specified voltage and temperature according to the correct operating instructions.
22. Some products are battery powered. Do not use any batteries, power sources or accessories not specified in the instructions for such products. Keep batteries and other accessories out of the reach of children and infants. In the instance that a child or infant swallows a battery or accessory, immediate emergency medical attention is required. If the battery leaks, becomes discolored, deformed, emits smoke, or emits an abnormal odor, remove it immediately. Be careful during removal to avoid burns. Continued use could result in fire, electric shock, or burns. Do not use any deformed or modified batteries. Do not disassemble or modify this product or battery. Do not heat or solder the battery. Keep the battery away from fire or water. Do not incorrectly insert the positive and negative ends of batteries, or mix old and new batteries or batteries of different types together.
23. One-year warranty period, accessories such as consumable batteries, adapters, power cords, etc. are not covered by this warranty.
24. If it is found that the equipment is repaired without authorization, the one-year warranty period will be cancelled and relevant fees will be charged for maintenance.
25. Machine failures caused by non-standard operation are not covered by the warranty.

**keep these instructions!**

## Foreword

Thank you for purchasing!

Godox Dive Light series has a IP68 waterproof function of up to 40 meters, ultra-high output power, Bluetooth APP smart control, 13 realistic light effects and adjustable brightness from 0% to 100%. This series can be widely used for filling light in diving, underwater photography, underwater recording, underwater light show and etc.

## Main Features

- Smart brightness adjusting ability to automatically enter high light mode under water.
- Waterproof rate IP68, workable up to 40m underwater.
- Support Bluetooth APP remote control (only workable in abovewater mode).
- Battery level indication gives convenience and utility.
- Selectable mounting methods: 1/4" screw or 1/4" to 1" ball joint.
- 13 FX modes and freely adjustable brightness.
- WT25D and WT40D support fast charging through USB Type-C port.

## ▲ Warning

- ▲ Do not disassemble. Should repairs become necessary, this product must be sent to an authorized maintenance center.
- ▲ Keep out of reach of children.
- ▲ Do not use the product in the presence of flammable gases, chemicals and other similar materials. In certain circumstance, please pay attention to the relevant warnings.
- ▲ Built-in lithium battery, do not disassemble, impact, squeeze or put it into fire. If serious bulge occurs, please do not use.

- ▲ Do not leave or store the product if the ambient temperature reads over 50°C.
- ▲ Please use the proper charger and follow the operation instruction.
- ▲ Make sure to seal the charging port with silicone lid and then close the cover before using under water.
- ▲ Please wash it with clean water and put it in a dry and ventilated place after using in the sea.

## Name of Parts

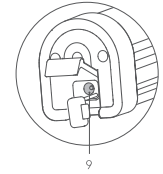
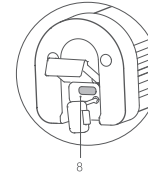
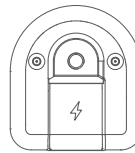
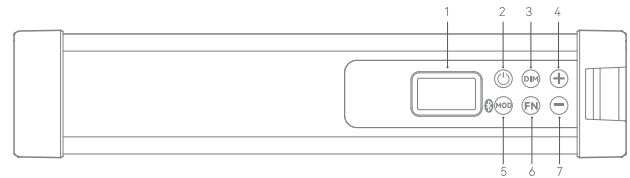

- |                         |                                       |
|-------------------------|---------------------------------------|
| 1. OLED Panel           | 6. FN Button                          |
| 2. Power Switch         | 7. - Button                           |
| 3. DIM Button           | 8. Type-C Charging Port (WT25D/WT40D) |
| 4. + Button             | 9. DC Charging Port (WT60D)           |
| 5. MOD/Bluetooth Button |                                       |

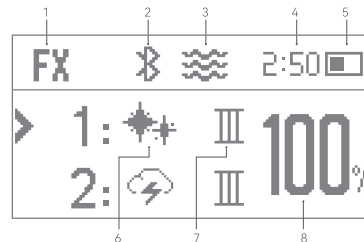

- |   |
|---|
| 1. FX Icon  |
| 2. Bluetooth  |
| 3. Underwater Highlight Mode                          |
| 4. Battery Life (only displays in the main interface) |
| 5. Battery Level                                      |
| 6. FX Mode  |
| 7. FX Level   |
| 8. DIM Adjust Ratio                                   |

## Item List

Model	Item List
WT25D	Light body*1, Type-C charging cable*1, Portable rope*1, 1/4" to 1" ball joint *1, Carry Bag CB67*1
WT40D	Light body*1, Type-C charging cable*1, Portable rope*1, 1/4" to 1" ball joint *1, Carry Bag CB68*1
WT60D	Light body*1, Adapter*1, Power cable*1, Portable rope*1, 1/4" to 1" ball joint *1, Carry Bag CB69*1

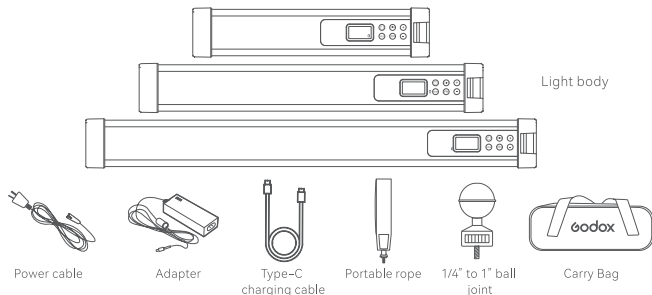

Note: Due to continuous updates and upgrades of the products, there may be differences between the actual products and the pictures. Therefore, the pictures are for reference only, products to prevail in kind.

## Separately Sold Accessories

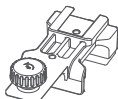

Light clamp WT-C01

## Operation Instruction

### 1. Power Switch

Long press the power switch for 1 second to power on or off the device. When the light is on in power on status, short press the power switch once to turn off the light, the DIM value is 0%, short press again to resume the previous DIM value.

### 2. Brightness Adjustment

In the main interface, short press the + button once can increase the DIM value by 1 unit, long press the + button can increase the DIM value quickly. Short press the - button once can decrease the DIM value by 1 unit, long press the - button can decrease the DIM value quickly.

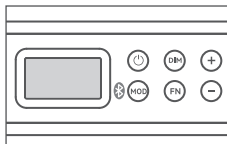

### 3. FX Mode

Short press the MOD/Bluetooth button to switch to FX mode.

**FX Brightness Adjustment:** In the FX mode interface, short press the DIM button once to make the DIM value blinks, then short press the + button once can increase the DIM value by 1 unit, long press the + button can increase the DIM value quickly. Short press the - button once can decrease the DIM value by 1 unit, long press the - button can decrease the DIM value quickly. Finally, short press the DIM button once can exit the brightness setting. It will automatically exit the brightness setting when the DIM value stops blinking after 10 seconds of idle use.

**FX Selection:** In the FX mode interface, short press the FN button can switch FX type. Short press the FN button twice quickly can switch to the previous FX type, Short press the + button or - button can adjust the FX level.

FX Table of WT25D/WT40D/WT60D (13 kinds within 5 types)

NO.	Icon	Scene	Display I	Display II	Display III
1		Flash	Flash	Press conference	Paparazzi
2		Lightning	Discontinuous	Frequent	Sustainable
3		Broken Bulb	Discontinuous	Frequent	Sustainable
4		TV	Slow speed	Medium speed	Quick speed
5		SOS			



### 4. Mode Description



Abovewater Mode



Underwater Highlight Mode  
(☼ is displayed on the panel)

### 5. Calibrating Function

The calibrating function is helpful when there are abnormalities in switching between abovewater mode and underwater mode.

**Calibrating mode:** Long press the MOD button and - button at the same time when the light is dry in abovewater mode to enter calibrating mode.

When the "Calibrating" is displayed on the panel, it means calibration is in process.

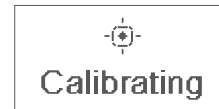

When the "✓" and "Done" is displayed on the panel, it means calibration is completed.

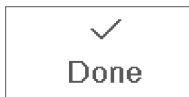

When the "✗" and "Failed" is displayed on the panel, it means calibration is failed.

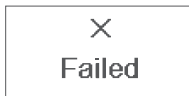

## 6. Bluetooth Setting

Long press the MOD/Bluetooth button to enter Bluetooth setting interface. Short press the FN button to choose Bluetooth switch (ON/OFF) or Bluetooth reset. If you choose Bluetooth switch, short press the + button or - button to turn on or off the Bluetooth. If you choose Bluetooth reset, short press the + button or - button to reset the Bluetooth. When "Reset" is displayed on the panel, it means resetting, after which, it will return to Bluetooth setting interface automatically.



Scan the following QR code to download "Godox Light" mobile APP (both Android and IOS systems are available).

For specific operations, please refer to the "Help" manual of the mobile APP, which contains detailed instruction.

Note: the APP can be used directly on the firstly installed device (smartphone or tablet). When changing to other mobile devices, the light shall be reset before normal usage of APP.

## 7. Abnormal Charging Alert

When the  icon appears on the display, there may be battery abnormality, charger abnormality or other abnormalities.



Abnormality alert interface in power on status



Abnormality alert interface in power off status

## Illuminance Data

### WT25D

CCT	Mode	Illuminance Unit	0.5m	1m	2m
5600K	Underwater	lux	2200	570	149
		fc	204	53	14
	Abovewater	lux	965	251	67
		fc	90	23	6

### WT40D

CCT	Mode	Illuminance Unit	0.5m	1m	2m
5600K	Underwater	lux	4820	1290	335
		fc	448	120	31
	Abovewater	lux	1410	385	99
		fc	131	36	9

### WT60D

CCT	Mode	Illuminance Unit	0.5m	1m	2m
5600K	Underwater	lux	6520	1940	571
		fc	606	180	77.8
	Abovewater	lux	2210	665	192
		fc	206	60.9	17.9

All the above tests are based on the condition of 100% brightness.

## Technical Data

Model	WT25D	WT40D	WT60D
Power supply	5V/2.5A, 9V/1.5A, 12V/1A, 15V/0.8A, 20V/0.75A	5V/3A, 9V/3A, 12V/3A, 15V/2.7A, 20V/2A	20V/3.25A
Power underwater	Max.24W	Max.54W	Max.70W
Power abovewater	Max.10W	Max.13W	Max.21W
Charging port	Type-C	Type-C	DC input port
CCT	5600K±300K		
TLCI	≥96		
CRI	≥96		
Brightness adjustment range	0%~100%		
Water proof rate	IP68 (40 meters underwater)		
Charging time	2h at the soonest	2h20min at the soonest	2h40min at the soonest
Battery life (100% brightness)	≈1h (underwater) ≈2h20min (abovewater)	≈1h20min (underwater) ≈5h30min (abovewater)	≈2h (underwater) ≈6h (abovewater)
Control Method	Bluetooth APP control(only abovewater)		
Bluetooth control distance	≈25m		
Working environment temperature	-10°C~40°C		
Dimension	57mm*52mm*250mm	57mm*52mm*380mm	57mm*52mm*640mm
Net Weight	0.64kg	1.08kg	1.9kg

Specifications and data may subject to changes without notice.

## ▲ Warning

Operating frequency: 2402MHz – 2480MHz  
 WT25D Maximum EIRP Power: 6.65dBm  
 WT40D Maximum EIRP Power: 6.7dBm  
 WT60D Maximum EIRP Power: 5.41dBm

## Declaration of Conformity

GODOX Photo Equipment Co.,Ltd. hereby declares that this equipment are in compliance with the essential requirements and other relevant provisions of Directive 2014/53/EU. In accordance with Article 10(2) and Article 10(10), this product is allowed to be used in all EU member states. For more information of DoC, Please click this web link:

<https://www.godox.com/eu-declaration-of-conformity/>

The device complies with RF specifications when the device used at 0mm from your body.

## FCC Statement

This device complies with part 15 of the FCC Rules. Operation is subject to the following two conditions:

- (1) This device may not cause harmful interference, and
- (2) this device must accept any interference received, including interference that may cause undesired operation.

Any Changes or modifications not expressly approved by the party responsible for compliance could void the user's authority to operate the equipment.

Note: This equipment has been tested and found to comply with the limits for a Class B digital device, pursuant to part 15 of the FCC Rules. These limits are designed to provide reasonable protection against harmful interference in a residential installation. This equipment generates uses and can radiate radio frequency energy and, if not installed and used in accordance with the instructions, may cause harmful interference to radio communications. However, there is no guarantee that interference will not occur in a particular installation. If this equipment does cause harmful interference to radio or television reception, which can be determined by turning the equipment off and on, the user is encouraged to try to correct the interference by one or more of the following measures:

- Reorient or relocate the receiving antenna.
- Increase the separation between the equipment and receiver.
- Connect the equipment into an outlet on a circuit different from that to which the receiver is connected.
- Consult the dealer or an experienced radio/TV technician for help.

The device has been evaluated to meet general RF exposure requirement.

The device can be used in portable exposure condition without restriction.

## Warranty

Dear customers, as this warranty card is an important certificate to apply for our maintenance service, please fill in the following form in coordination with the seller and safe-keep it. Thank you!

Product Information	Model	Product Code Number
Customer Information	Name	Contact Number
	Address	
Seller Information	Name	
	Contact Number	
	Address	
	Date of Sale	
Note		

Note: This form shall be sealed by the seller.

### Applicable Products

The document applies to the products listed on the Product Maintenance Information (see below for further information). Other products or accessories (e.g. promotional items, giveaways and additional accessories attached, etc.) are not included in this warranty scope.

### Warranty Period

The warranty period of products and accessories is implemented according to the relevant Product Maintenance Information. The warranty period is calculated from the day (purchase date) when the product is bought for the first time. And the purchase date is considered as the date registered on the warranty card when buying the product.

### How to Get the Maintenance Service

If maintenance service is needed, you can directly contact the product distributor or authorized service institutions. You can also contact the Godox after-sale service call and we will offer you service. When applying for maintenance service, you should provide valid warranty card. If you cannot provide valid warranty card, we may offer you maintenance service once confirmed that the product or accessory is involved in the maintenance scope, but that shall not be considered as our obligation.

### Inapplicable Cases

The guarantee and service offered by this document are not applicable in the following cases: ① The product or accessory has expired its warranty period; ② Breakage or damage caused by inappropriate usage, maintenance or preservation, such as improper packing, improper usage, improper plugging in/out external equipment, falling off or squeezing by external force, contacting or exposing to the improper temperature, solvent, acid, base, flooding and damp environments, etc; ③ Breakage or damage caused by non-authorized institution or staff in the process of installation, maintenance, alternation, addition and detachment; ④ The original identifying information of product or accessory is

modified, alternated, or removed; ⑤ No valid warranty card; ⑥ Breakage or damage caused by using illegally authorized, nonstandard or non-public released software; ⑦ Breakage or damage caused by force majeure or accident; ⑧ Breakage or damage that could not be attributed to the product itself. Once met these situations above, you should seek solutions from the related responsible parties and Godox assumes no responsibility. The damage caused by parts, accessories and software that beyond the warranty period or scope is not included in our maintenance scope. The normal discoloration, abrasion and consumption are not the breakage within the maintenance scope.

## Maintenance and Service Support Information

The warranty period and service types of products are implemented according to the following Product Maintenance Information:

Product Type	Name	Maintenance Period(month)	Warranty Service Type
Parts	Circuit Board	12	Customer sends the product to designated site
	Battery	3	Customer sends the product to designated site
	Electrical parts e.g.battery charger, etc.	12	Customer sends the product to designated site
Other Items	Flash tube, power cord, sync cable, modeling lamp, lamp body, lamp cover, locking device, package, etc.	No	Without warranty

Godox After-sale Service Call +86-755-29609320(8062)